Table of Contents

SEAT, MIRROR AND STEERING COLUMN FUNCTIONS

Subject	Page
Introduction.	3
System Overview.	4
Components.	6
Switch Block, Driver and Passenger.	7
Center Console Control Center (BZM).	8
Seat Modules (SMFA/SMBF).	8
Principle of Operation	
Seat Memory.	9
Seat Heating.	12
Seat Ventilation.	16
Lumbar Support.	18
Active Seat.	19
Exterior Rear View Mirrors.	21
Electric Steering Column Adjustment.	25
Steering Wheel Heating.	27
Review Questions.	28

SEAT, MIRROR AND STEERING COLUMN FUNCTIONS

Model: E65 - 745i

Production Date: 11/2001 - Start of Production

Objectives:

After completing this module you should be able to:

- Understand the communication path and what modules are used to perform the memory functions of the seat, mirror and steering column.
- Describe how to store and call up memory positions.
- Explain the new operation and control of the seat heating system.
- Describe the new functions of the comfort seat.

Introduction

The E65 can be equipped with several different seat versions.

Front Seat Versions

The front seats come in 2 versions:

- **Standard:** 14 way Basic Seat (12 way passenger), electrically adjustable with memory and 4 way lumbar. The head-restraints of the basic seat are not separately adjustable; they are controlled by a cable mechanism automatically when the seat is moved forward or backwards. This allows the head restraint to always be in the optimum position for safety. Seat heating is available as a stand alone option or part of the cold weather package
- **Optional active seat package:** 20 way Comfort Seat with memory, 4 way lumbar, seat ventilation and active seat feature. The head restraints are controlled automatically with forward/backward movement of the seat. However, positioning is done electrically and it allows separate electric adjustment of the head restraint. Seat heating is also available for the comfort seat as a stand alone option or part of the cold weather package.



Rear Seat Versions

The E65 comes equipped only with the basic rear seat. Head restraint adjustment is automatic if equipped with the rear safety package.

The rear seats will have optional rear heating available as part of the cold weather package.

There will be a comfort seat with memory for the rear when the E66 745Li is introduced later.



Exterior Rearview Mirrors

The exterior rearview mirrors are electrically adjustable and heated. They are also equipped with electro-chromatic auto dimming and are part of the seat memory system.



Steering Column Adjustment

Steering-column adjustment is fully electric.

System Overview

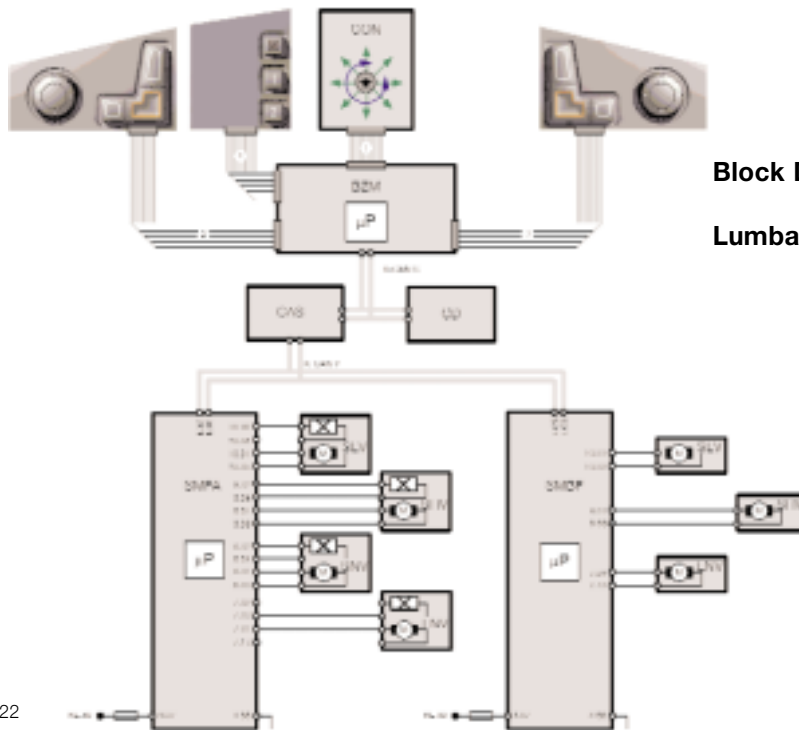

Block Diagram: Basic seat

Lumbar components are not shown.

kt-8722

Index	Description	Index	Description
BZM	Center console control center	SLV	Longitudinal seat adjustment
CON	Controller	SHV	Seat height adjustment
CAS	Car Access System	SNV	Seat inclination adjustment
SMFA	Seat module drivers side	LNV	Backrest inclination adjustment
SMBF	Seat module passenger side	1	16 pin ribbon cable
K-CAN-S	K-CAN-System	2	12 pin ribbon cable
K-CAN-P	k-CAN-Periphery	3	12 pin ribbon cable
KL 30	Terminal 30	4	14 pin ribbon cable

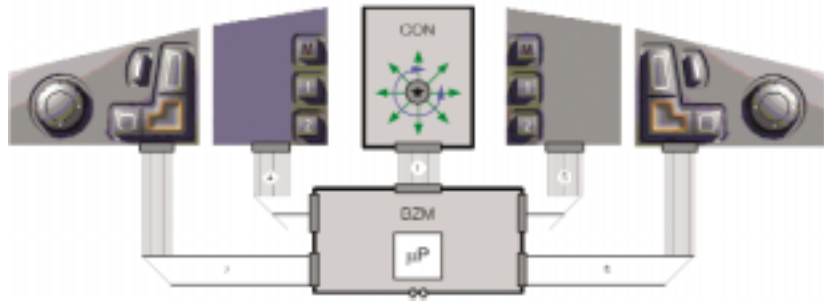

Block Diagram: Comfort seat.

Lumbar, ventilation and active seat components are not shown.

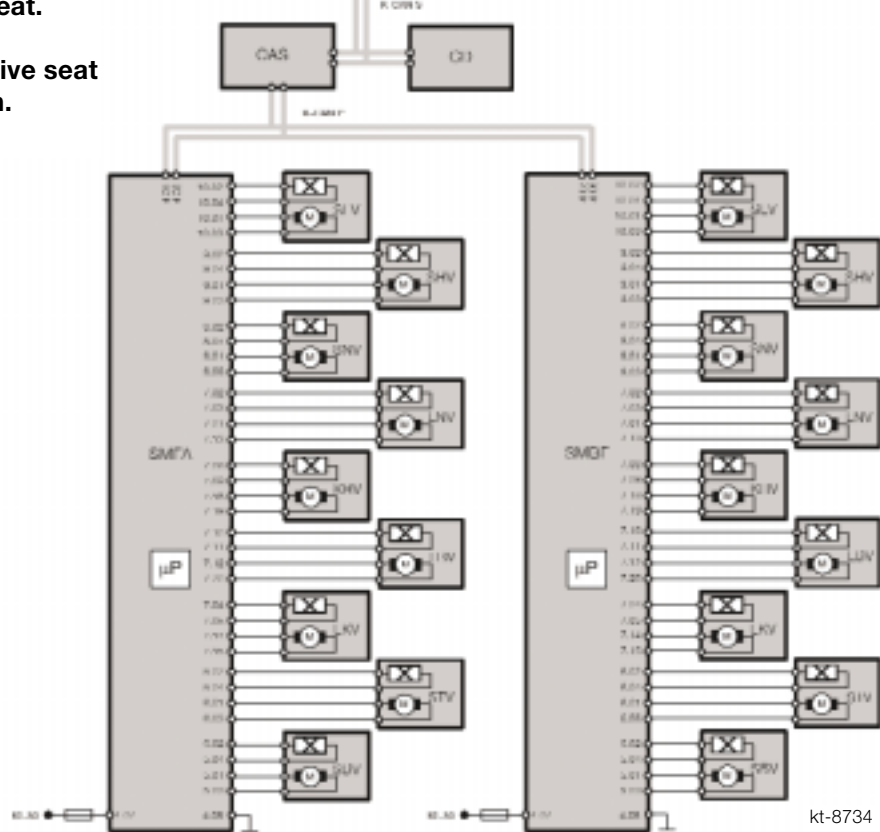

Index	Description	Index	Description
BZM	Center console control center	K-CAN-S	K-Can System
CON	Controller	K-CAN-P	K-CAN Periphery
CAS	Car Access System	1	16 pin ribbon cable
CD	Control Display	2	12 pin ribbon cable
SMFA	Seat module, drivers side	3	12 pin ribbon cable
SMBF	Seat module, passenger side	4	14 pin ribbon cable
KL 30	Terminal 30	5	14 pin ribbon cable
SLV	Longitudinal seat adjustment	LNV	Backrest inclination adjustment
SHV	Seat height adjustment	LBV	Backrest width adjustment
SNV	Seat inclination adjustment	LKV	Backrest head adjustment
STV	Seat cushion adjustment	KHV	Head restraint height adjustment
SBV	Seat width adjustment		

System Interface

The variety of comfort functions are distributed to various control units. Communication between the relevant control units is conducted by way of the bus, especially to carry out the memory functions.

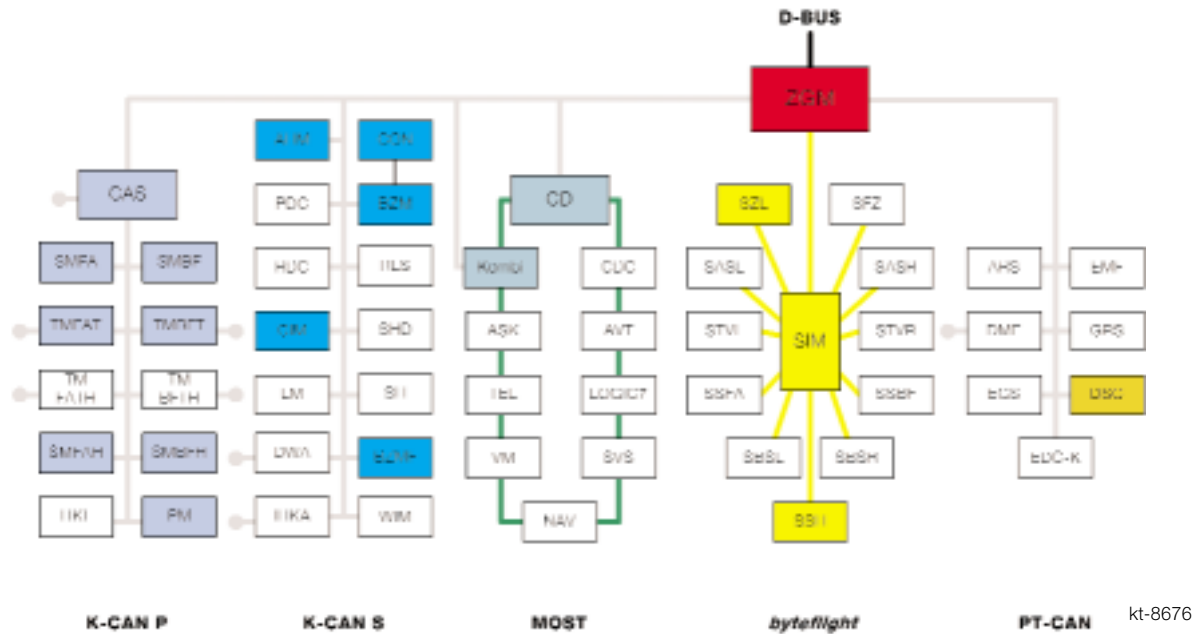

Components

Component overview:

- Switch block, driver and passenger side
- Center console Control Center (BZM)
- Car Access System (CAS as gateway))
- Seat module, driver and passenger side (SMFA/SMBF)
- Seat-adjusting motors (memory seats include hall sensors for position detecting)
- Air pump, bladders and solenoids for lumbar support

Additional equipment for comfort seats:

- Active seat unit per seat
- 9 smart fans per seat for seat ventilation

Optional equipment for basic or comfort seats:

- Seat heating elements

Switch Block, Driver and Passenger

The controls for the driver and passenger seat have been relocated from the seat side panel and are now part of the center console. The switch block consists of two separate switch assemblies.

The forward switch assembly contains a control knob and menu buttons in the shape of a seat for function selection.

The rearward switch assembly contains the memory function buttons and possibly three more features:

- Seat heating control
- Seat ventilation control
- Active seat control

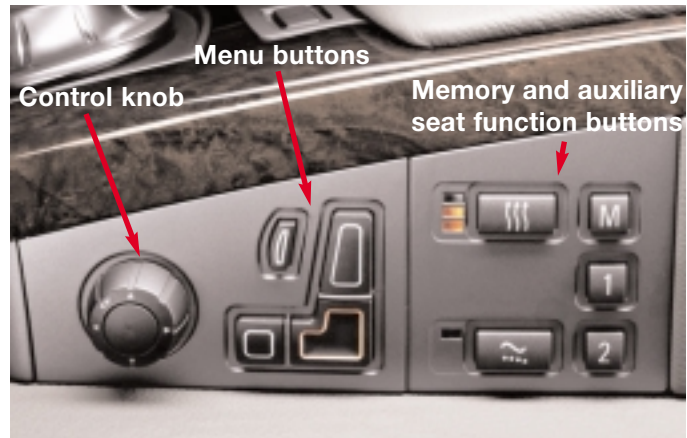

LEDs indicate the operating status of each particular seat auxiliary function.

The adjustment request is transmitted from the switch block via ribbon cables to be processed by the BZM.

Switch Operation



kt-8636

1. **Selection button for Lumbar and back-width adjustment (comfort seat).**
2. **Selection button for shoulder tilting (comfort seat), backrest inclination and head-restraint height (comfort seat) adjustment.**
3. **Selection button for forward/back (longitudinal) seat height and backrest inclination adjustment.**
4. **Seat cushion tilting, Thigh support.**

The selected menu button lights up to confirm the request

The control knob is a “joystick” that can be pushed or rotated. It is used to control whichever portion of the seat has been selected using the menu buttons.

The operation of the memory and auxiliary seat function buttons is discussed separately in “Principle of Operation”.

Center Console Control Center (BZM)

The BZM is located in the center console directly below the Controller. The BZM interprets the signals from the seat blocks and makes the message available to the CAS on the K-CAN-System.

The CAS as the gateway, forwards the messages to the K-CAN-P where they can be received by the seat modules.

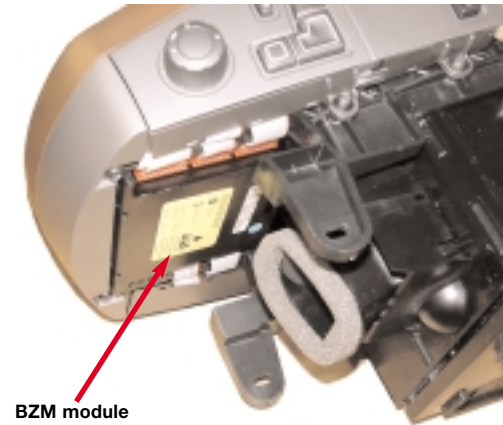

Seat Modules (SMFA, SMBF)

The Seat Modules are located below the driver's and passenger's seat next to the seat satellites.

They are clipped into a plastic carrier. The Seat Modules have 10 connectors

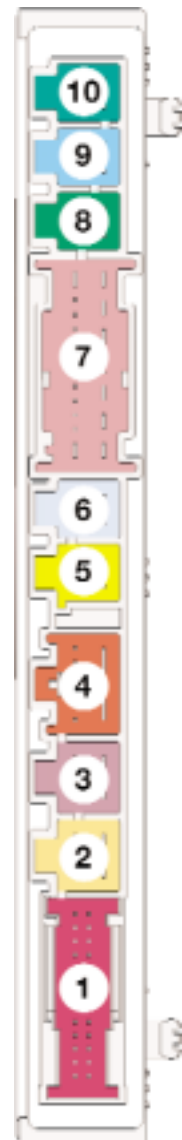
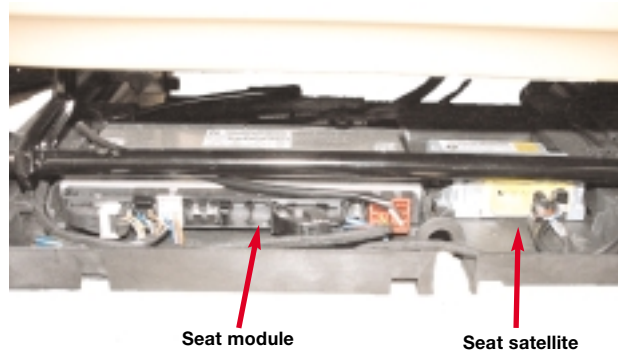

Both the driver's and passenger's seat modules are identical. The modules are recognized by an additional ground on the drivers side module at pin 2 of X275 (8-pin).

The seat module activates the seat-motors directly via final stages. Up to 3 motors may be run simultaneously.

The total running time of each adjusting motor is monitored in order to prevent thermal overloading.

The seats equipped with memory use motors with integral hall sensors for position detecting.

The position of the mechanical stops is stored on initial operation. In the following adjustments, the seat stops before this position is reached (soft stop).

(The soft stop can be overridden if the seat is operated in the same direction immediately afterwards).

In the comfort seat, the 4 main seat adjustments are equipped with a smooth startup:

- SLV: Longitudinal seat adjustment(forward/backward)
- SNV: Seat-inclination adjustment
- SHV: Seat-height adjustment
- LNV: Backrest-inclination adjustment

Principle of Operation

Seat Memory

The seat memory offers the opportunity of storing up to 3 different positions (2 memory pre-sets and “last position used”) for every Remote Control used.

This means that if 4 Remote Controls have been assigned to the vehicle, up to 12 different positions can be stored in the individual seat module.

Availability of these 12 positions depends on whether Key Memory is set to “active” or “not active”. With Key Memory set to “**not active**”, only 3 memory positions are available. They are assigned to the vehicle irrelevant of the Remote Control being used.

With Key Memory set to “**active**”, memory presets stored are assigned to the Remote Control that is currently being identified (memory preset 1 and 2 and the “last position used”). The number of stored positions then becomes 3 X the number of remote controls assigned up to a maximum of 4 (12 positions).

Remote Control 1			Remote Control 2			Remote Control 3			Remote Control 4		
1	2	3	4	5	6	7	8	9	10	11	12
Key	Mem. 1	Mem. 2	Key	Mem. 1	Mem. 2	Key	Mem. 1	Mem. 2	Key	Mem. 1	Mem. 2

The following components are required for the seat-memory function:

- Memory buttons, driver’s and passenger’s
- Center Console Control Center (BZM)
- Car Access System (CAS)
- Seat module, driver and passenger (SMFA/SMBF)
- Seat-adjusting motors with a Hall sensor

The SMFA/SMBF requires information from the CAS in order to execute the stored seat positions: Remote Control number and memory buttons (from the BZM).

- The information is sent from the CAS via the K-CAN P to the seat module.
- The seat-adjusting motors are then activated accordingly.

When using the Remote Control to unlock the vehicle, the seat automatically moves to the last position used for that Remote Control.

If an unlocked car is entered and no button of the Remote Control is pressed, the seat moves to the last position stored once the Remote control is identified by the CAS.

At the same time, the CAS sends the same information to:

- The front door modules for the mirror-memory position
- The CIM (Chassis Integration Module) for the steering column memory positions.

Memory Preset buttons

The memory buttons are integrated in the memory/auxiliary function switch block (behind the adjusting-switch block) and consist of:

- Pad with 3 buttons (position buttons 1 and 2 and a memory storage button)
- Indicator LED in memory storage button for memory readiness

Depending on the special equipment fitted, the buttons for the following functions can be integrated in the switch block:

- Seat heating
- Seat ventilation
- Active seat

The status of the memory button is communicated to the relevant seat module over the bus system.

Signal path: Button - ribbon cable - BZM - K-CAN-S - CAS - K-CAN-P - SMFA or SMBF.

The position of the lumbar support cannot be stored.



kt-8679

Programming

Programming of seat positions is only possible from terminal R "on".

The following operating steps must be performed in order to store a seat position:

- Press memory button "M": The memory button lights up to acknowledge programming readiness.
- Press position button: adoption of current position of seat, steering column and side mirrors.
- Programming readiness is deactivated if no position button is pressed within 7 seconds while it is activated. The function indicator is deactivated.
- Programming readiness is also deactivated when the memory button is pressed again.
- If no personalization key is recognized, the programming function is not available when the key memory is activated.

Calling Up Memory Positions

There are 2 operating modes for calling up stored positions on the driver's seat:

- One touch mode: touching the desired position button moves the seat automatically up to the end setting of the stored positions. The one-touch function is only possible with terminal 15 "off" to eliminate any safety hazard caused by accidental touching of the button.
- Continuous hold mode: the seat moves only as long as the desired position button is continuously pressed. The motors are shut down immediately if the button is released before the target position is reached. Pressing the position button again resumes the positioning up to the end setting of the stored position (target position).

Seat Heating

Seat heating is an option or part of the cold weather package.

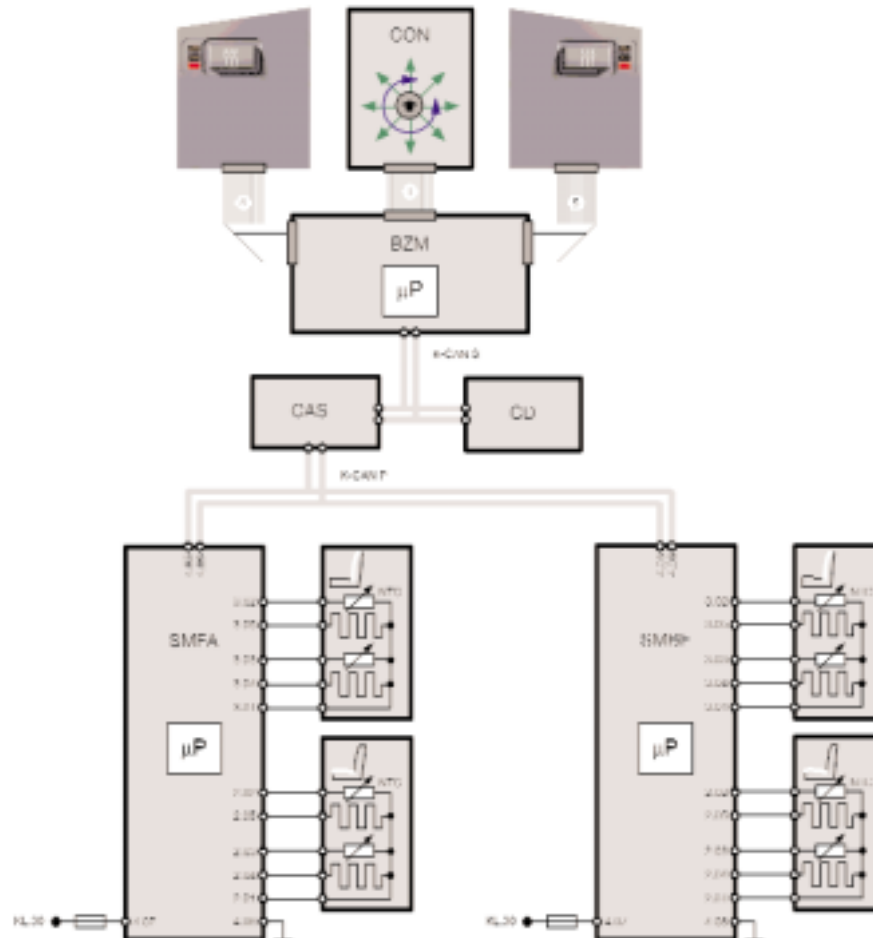

kt-8759

The following components are required for the seat-heating function:

- Switch block, auxiliary functions, driver and passenger
- BZM
- Controller (CON)
- Control display (CD)
- Car Access System (CAS)
- Seat module, driver and passenger (SMFA/SMBF)
- 2 rapid heating elements per seat
- 2 regular heating elements areas per seat
- 4 temperature sensors

The switch block contains the control button and 3 orange LEDs. The LEDs indicate the various heating stages.

The signals for operating the seat heating are transmitted over the buses.

Signal path: Button - 14-pin ribbon cable - BZM - K-CAN S - CAS - K-CAN P - SMFA or SMBF.

The seat modules incorporate activation and control of seat heating. Each seat has 4 heating elements, which are sewn into the seat cover:

- 1 rapid heating element in each inner seat cushion area and in inner backrest area.
- 1 residual heating element in each outer seat cushion area and in outer backrest area.

Each heating element is monitored by an NTC temperature sensor.

1. Rapid heating element

2. Regular heating element

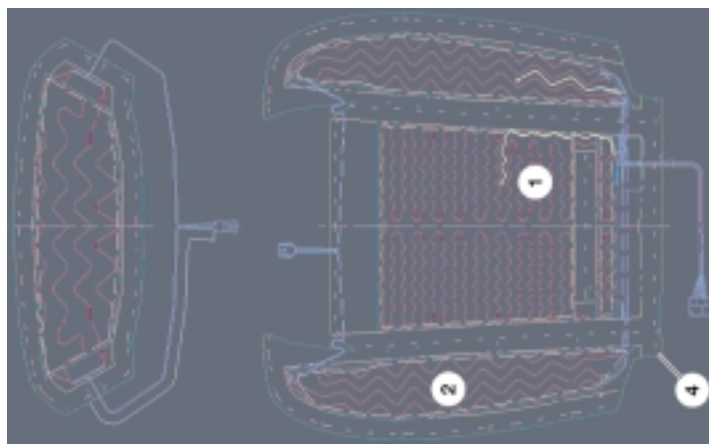
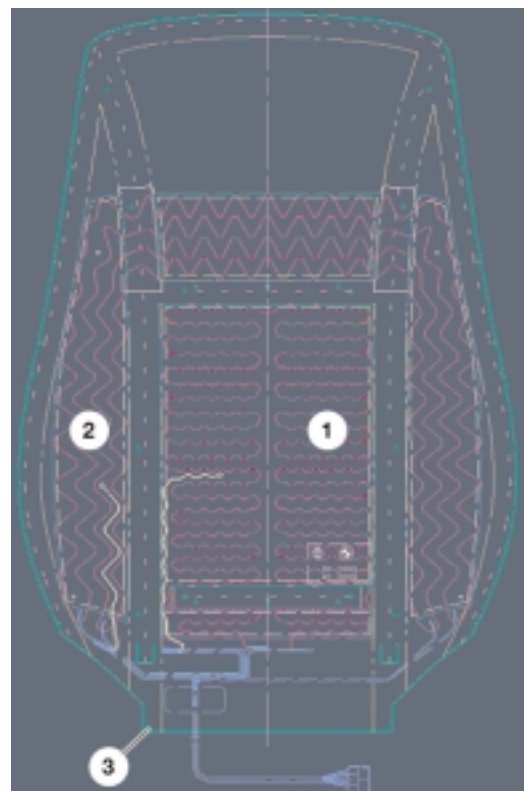
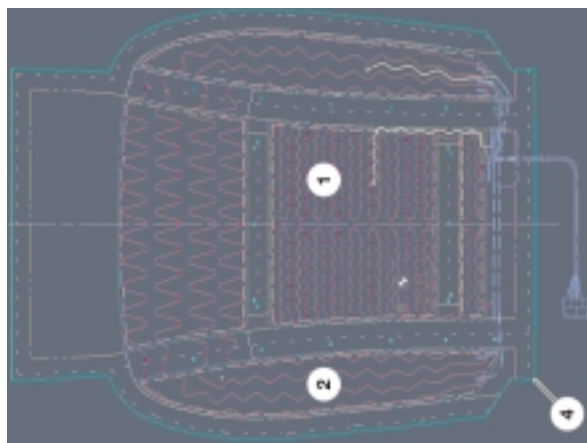

3. Backrest cover

4. Seat cushion cover

Activation of Heating Areas

When the seat heating is turned on, the rapid heating elements are activated first in order to heat up the seats quickly.

After the initial rapid heating, the regular heating areas are activated in order to ensure a uniform distribution of temperature in the seat.

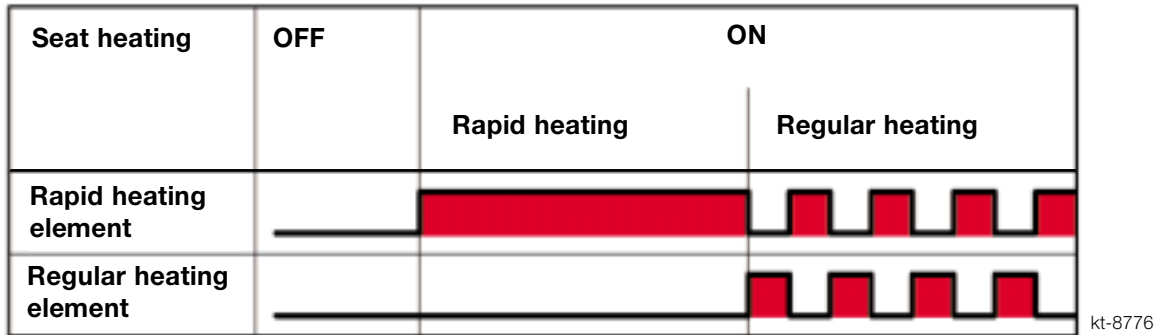

Activation of all the heating elements is PWM so that an established current intensity is not exceeded during regular heating. The duty factor is dependent on the selected heating stage, the ON period and the heating-area temperatures.

The function indicators (LEDs) of the seat heating remain on if the heating is briefly deactivated (e.g. during seat adjustment or by power management).

Operation

The seat heating can be turned on from terminal 15 and the engine running. Stage 3 (maximum temperature) is activated when the button is pressed for the first time. Each subsequent pressing of the button selects the next stage lower or "off". The seat heating is turned off if the button is pressed for longer than 1.2 seconds.

The seat heating remains in stand-by (service station feature) for 15 minutes after terminal 15 is switched off.

Balance Control

The vehicle occupant can use a balance controller to adjust a temperature differential between the seat cushion and the backrest up to +/- 3 °C.

The balance controller can be called up in the Control Display and is set with the Controller. This setting remains permanently stored specifically to each Remote Control (Key Memory activated).

For balance control, switch to the Climate menu and call up seat heating from the second page. Select driver's or passenger seat.

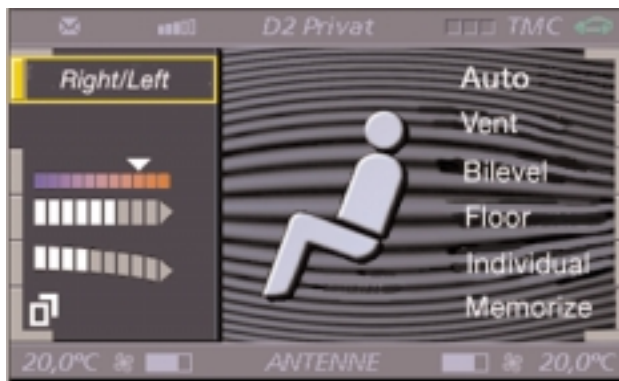

1. Select second page from climate menu

2. Select seat heating

3. Select left or right seat

4. Rotate Controller to vary the ratio of heat between the backrest and cushion

The driver's or passenger seat can be selected in this menu. Turn the Controller to vary the balance of heat output between the seat surface and the backrest. This change in balance is indicated by a red/white coloring of the seats in the Control Display.

Seat Ventilation

The seat ventilation feature of the comfort seat allows the front seat occupants to cool the seat cushion and backrest.

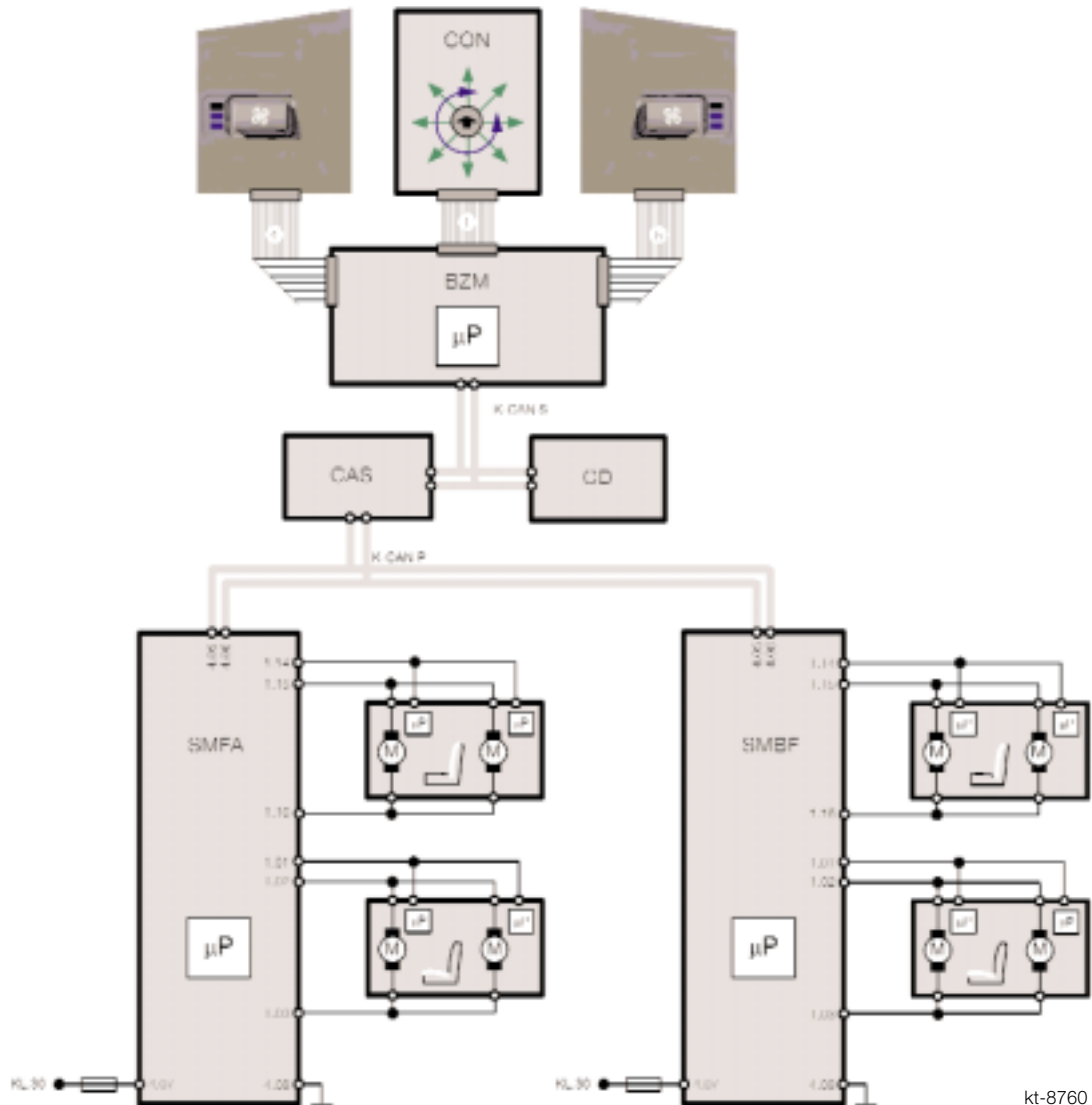

kt-8760

The following components are required for the seat ventilation function:

- Switch block, auxiliary functions, driver and passenger
- BZM
- Car Access System (CAS)
- Seat module, driver and passenger (SMFA/SMBF)
- 9 smart ventilation fans per seat

The auxiliary function switch block contains the control button and 3 LEDs for displaying the ventilation stage.

The signals for operating the seat ventilation are transmitted over the buses.

Signal path: Switch block - 14-pin ribbon cable - BZM - K-CAN S - CAS - K-CAN P - SMFA or SMBF.

The relevant seat module activates and monitors the fans. The fans:

- Are activated by the seat modules supplying voltage.
- Can be activated separately for back rest and seat cushion.
- Can be operated in 2 speed stages (high and low) via a control/diagnosis line.
- Indicate possible jamming for diagnosis over the control/diagnosis line.

Fault code only identifies whether the defective fan is in the backrest or the cushion it does not identify individual fan motors.



Operation

The seat ventilation can be turned on from KL 15 "on" and the engine running.

Seat ventilation has 3 stages but only two fan speeds:

- Stage 3: High speed backrest, high speed cushion (seat bottom)
- Stage 2: low speed backrest, high speed cushion
- Stage 1: low speed backrest, low speed cushion

Stage 3 is activated when the button is pressed for the first time. Each subsequent pressing of the button selects the next stage lower or "off". The seat ventilation is turned off if the button is pressed for longer than 1.2 seconds.

The system switches down automatically from stage 3 to stage 2 after an running time of 15 minutes. The ventilation remains in stand-by for 15 minutes after KL R off is received.

Lumbar Support

Both seat versions are available with pneumatic lumbar adjustment as standard equipment.

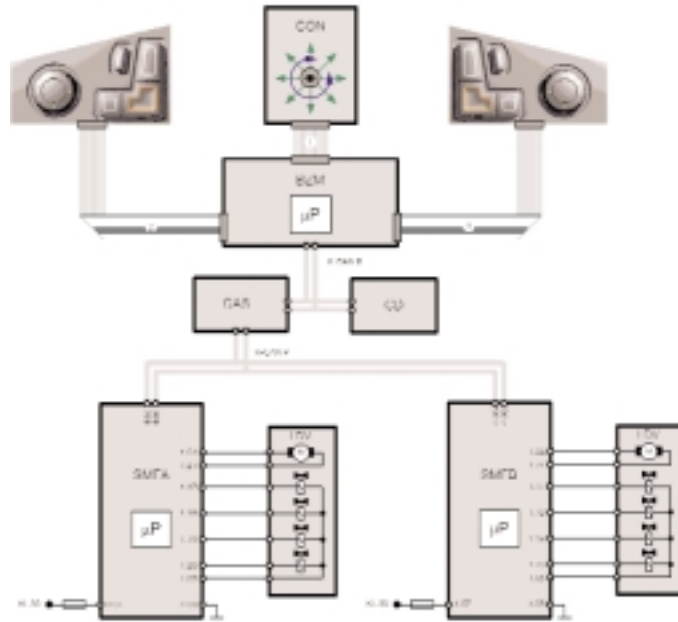

kt-8763

The following components are required for the lumbar support function:

- Switch block, auxiliary functions, driver and passenger
- BZM
- Car Access System (CAS)
- Seat module, driver and passenger (SMFA/SMBF)
- 2 inflatable air chambers (bladders) and 2 solenoids per seat
- 1 air pump per seat

Operation

Lumbar adjustment is performed by 2 inflatable chambers (air bladders) in the backrest. The air chambers are inflated and deflated by 2 solenoid valves. The air pump delivers the required air pressure.

The air pump and the actuators are activated by the seat module based on the commands from the seat switch block.

The signals for operating the lumbar support are transmitted over the buses.

Signal path: Switch block - 12-pin ribbon cable - BZM - K-CAN S - CAS - K-CAN P - SMFA or SMBF.

Active Seat

The active seat was introduced for the first time in the E38 for model year '99. The active seats in the E65 have been adapted to the E65 electrical system.

The active seats relieve the back muscles and spinal column on longer journeys. The seat cushion of the active seat is moved up and down in stages. For safety reasons, the active seat is paused when the vehicle is cornering.

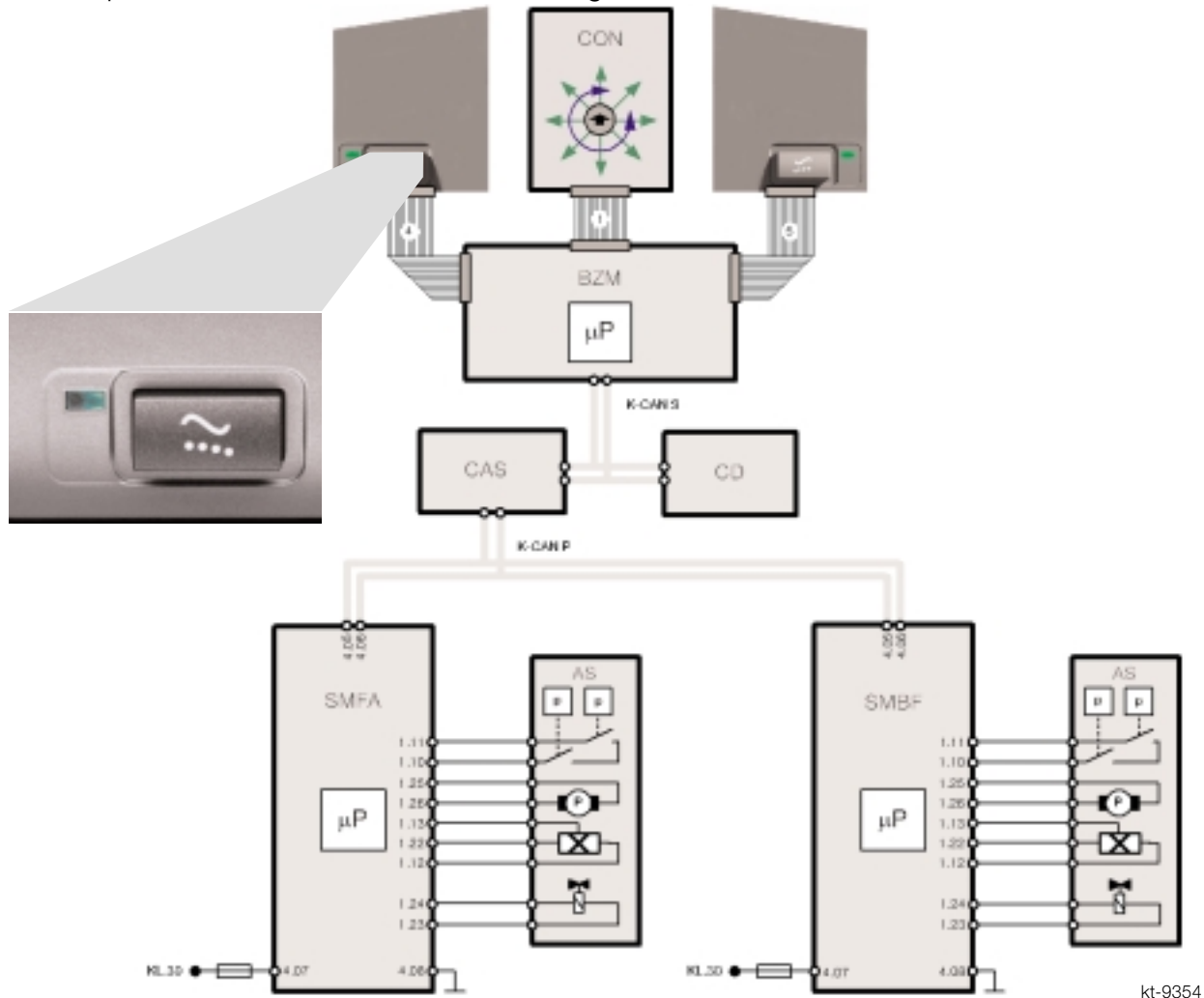

The following components are required for the active seat function:

- Switch block, auxiliary functions, driver and passenger
- BZM
- Car Access System (CAS)
- Seat module, driver and passenger (SMFA/SMBF)
- 1 active seat unit per seat

The signals for operating the active seat are transmitted over the buses.

Signal path: Switch block, auxiliary functions, active seat - 14-pin ribbon cable - BZM - K-CAN S - CAS - K-CAN P - SMFA or SMBF.

Functional Description

The system is filled with a glycol fluid. This fluid is pumped alternately into the left and right fluid bags (by reversing the direction of pump rotation).

The following components are required for the active-seat function:

- **Hydraulic pump:** the hydraulic-pump motor is activated with alternating polarity by semi-conductors in the seat module.
- **Hall sensor:** a Hall sensor records the revolutions of the hydraulic-pump motor. The motor function is monitored with this signal.
- **Solenoid valve:** the solenoid valve is installed between the two fluid bags and opens and closes the delivery to the fluid bags. The valve is activated by semiconductors in the seat module. The solenoid valve is closed when the system is deactivated and in the intervals between the adjustments. In order not to irritate the driver when cornering fast, the operational sequence of the active seat is stopped immediately at high transversal acceleration: the solenoid valve remains closed from a specific transversal vehicle acceleration. The yaw-rate sensor telegrams the transversal-acceleration signal via the bus system.
- **Vacuum switch:** a vacuum switch is installed in each of the fluid bags. These switches identify the extent to which the fluid bags are drained. In the event of a fault, the system stops or holds in order to avoid further damage.

Exterior Rearview Mirrors

2 electric rearview mirrors are fitted on the driver's and passenger doors of the E65. They are activated by the front door modules.

All the mirror functions are controlled by the buttons in the switch block in the driver's door. The mirrors are directly controlled by the associated door module.

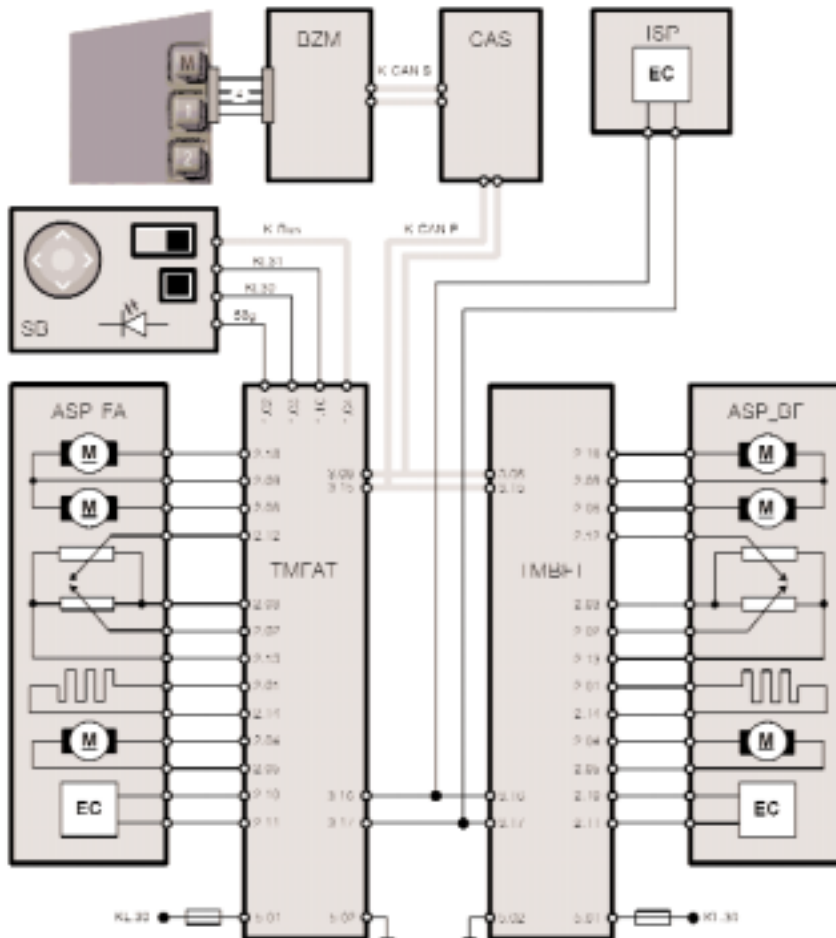

kt-8791

The following functions are possible:

- Horizontal and vertical mirror adjustment
- Mirror heating
- Automatic curb view
- Mirror memory
- Electro-chromatic
- Under-voltage deactivation

Horizontal and Vertical Mirror Adjustment

Both the exterior mirrors can be moved in the horizontal and vertical directions. However, they can only be adjusted in each case in one direction (horizontal/vertical).

Each exterior mirror accommodates 2 adjusting motors: one motor for each adjusting direction. Potentiometers are fitted for position detection.

A common control pad for both exterior mirrors is located in the driver's door.



The driver uses a slide switch to select between the two mirrors (right/left).

Mirror Heating

The function of the mirror heating is automatically controlled. The mirror heating is supplied via PWM signal.

The current output is dependent on outside temperature and wiper operation. The outside temperature and wiper operation are delivered via the K-CAN.

Temperature in C	<-10	-10 to 5	5 to 15	15 to 25	25 to 35	> 35
Percentage ON period	100%	100%	75%	25%	0%	0%
Percentage ON period with wiper actuation	100%	100%	75%	50%	25%	0%

The heat output is increased in wiper mode in order to make any raindrops on the mirrors evaporate.

When the wiper is deactivated, the higher percentage ON period remains active for a further 5 minutes. The mirror heating is operational from terminal 15 "on". It is deactivated with terminal 50 "on" (load deactivation during the starting sequence).

The mirror heating is deactivated with priority 4, 5 and 6 for the function "Optimum charging of Power Module" (see Power Management chapter).

- Cut-off voltage: 10.8V
- Cut-in voltage: 11.6V

Automatic Curb View

When the vehicle is being reversed, the passenger mirror is moved downward in order to provide a better view of the curb. Conditions needed are:

- The exterior-mirror selector switch for operating the driver's mirror is selected.
- Terminal 15 "on"
- Reverse gear is selected

Signal path: EGS - PT-CAN - ZGM - K-CAN S - CAS - K-CAN P - door module.

- Delay time: 1 second after selection of reverse gear (in order to avoid unnecessary activation of passenger mirror when reverse gear is accidentally selected).

The passenger exterior mirror immediately reassumes its original position:

- After the reverse gear has been deselected
- or with terminal 15 "off".

Manual mirror adjustment is disabled until the mirror reaches its initial position.

Mirror Memory

The mirror-memory function is part of the seat-memory function. The current mirror settings on the driver and passenger sides can be stored or mirror settings already stored can be re-called using the memory buttons in the vehicle and the Key-Memory function.

The memory positions are stored in the driver's/passenger's door modules.

The potentiometers for position detection are supplied by the door modules with a voltage of 5 V. The potentiometers are deactivated in sleep mode.

The various mirror-adjustments have different priorities.

- Manual mirror adjustment has priority over all other mirror adjustments. Manual mirror adjustment interrupts any memory adjustment.
- Mirror adjustment by means of the buttons of the memory function has priority over mirror adjustment by means of the Key Memory:

A mirror activation in progress which has been initiated by the Key Memory is cancelled when the memory buttons are operated.

Electro-chromatic Exterior Rearview Mirrors

Electro-chromatic exterior rearview mirrors ensure that the driver is not dazzled by the headlights of vehicles from behind.

The exterior mirrors are automatically dimmed when a light source coming from the rear is detected. The sensor and control electronics for this function are integrated in the inside rearview mirror.

- A photo sensor in the inside rearview mirror measures the amount of light coming from the rear of the vehicle as opposed to the front.
- The control electronics calculates the amount of dimming required for this incidence of light. Stronger or weaker dimming of the exterior mirrors is performed depending on the degree of potential dazzling.

The control signals are transmitted from the inside rearview mirror via the front door modules to the exterior mirrors.

Under-voltage Deactivation

Under-voltage deactivation ensures that primary electrical-system functions take priority over the mirror functions.

The supply voltage is monitored locally in the door modules. All the mirror functions are disabled if the supply voltage drops below 8.5 V.

Once the voltage has dropped below this limit, the mirror functions are not available again until system voltage increases over 9 V.

Electric Steering-Column Adjustment

The electrically adjustable steering column is adjusted (inclination and length) with the steering-column adjusting switch on the left side of the steering-column cover.

Electric adjustment of the steering column is effected by the Chassis Integration Module (CIM). The CIM controls the motor gearbox unit for adjustment.

The motors are activated internally by a power semiconductor. The steering column is moved into the upmost position for entry and exit purposes (automatic entry facility).

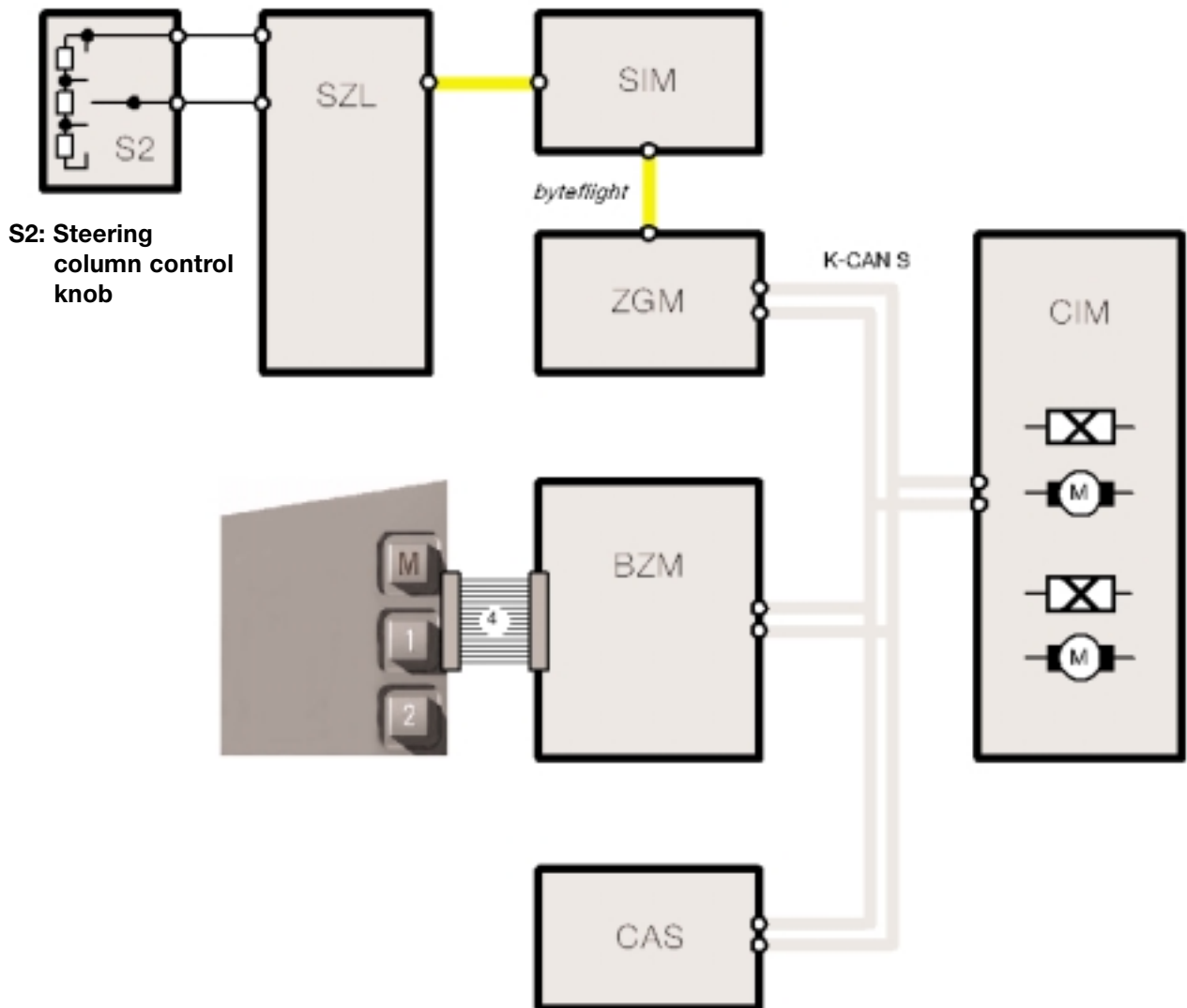

Automatic Entry

The electrically adjustable steering column is moved into the upper-most position for entry and exit purposes. The automatic entry facility is activated when:

- Terminal 15 "off" and terminal R "off".
- Terminal 15 "off" while driver's door is open.
- Driver's door is opened after terminal 15 "off", also when terminal R is still activated.

The automatic entry is deactivated when terminal 15 is re-activated; the return position is approached. Automatic operation stops if the control switch for steering-column adjustment is operated during automatic entry.

The previous return position is overwritten if automatic entry is interrupted by operation of the steering-column adjustment control switch.

The return position is retained if while the automatic entry is active, the control switch inputs: "steering column up" (towards headliner) or "steering column forward" (towards instrument cluster) are operated.

If the memory is called up while automatic entry is active, the memory steering-column position is assumed only after the automatic entry has been completed. The normal return position is substituted by the called-up memory position.

Soft Stop

If the steering column reaches a mechanical stop during adjustment, this position is permanently stored. Starting out from this value, the adjustment travel for future adjustments is restricted to eliminate any future mechanical blocking.

This soft stop can be manually overridden if the column is operated in the same direction immediately afterwards.

Steering-Column Memory

A Hall sensor is fitted in each of the adjusting motors. The Hall sensors record the steering-column position for the memory functions. 2 different positions can be stored by means of the seat-memory buttons in the switch block.

The memory positions are stored in the driver's seat module (SMFA). Automatic operation stops if the switch for steering-column adjustment is operated during activation of the memory steering-column position.

Steering Wheel Heating

The steering wheel heating is available as an option or as part of the cold weather package.

It is operational from terminal 15 "on". It is activated and deactivated by pressing the button on the left side of the steering-column cover. The LED indicator light in the button illuminates when the steering wheel heating is activated.

The temperature in the steering wheel is monitored by a sensor and maintained at 36 °C. The control electronics are in the SZL. The load current is passed on by the coil spring and the steering wheel electronics module.

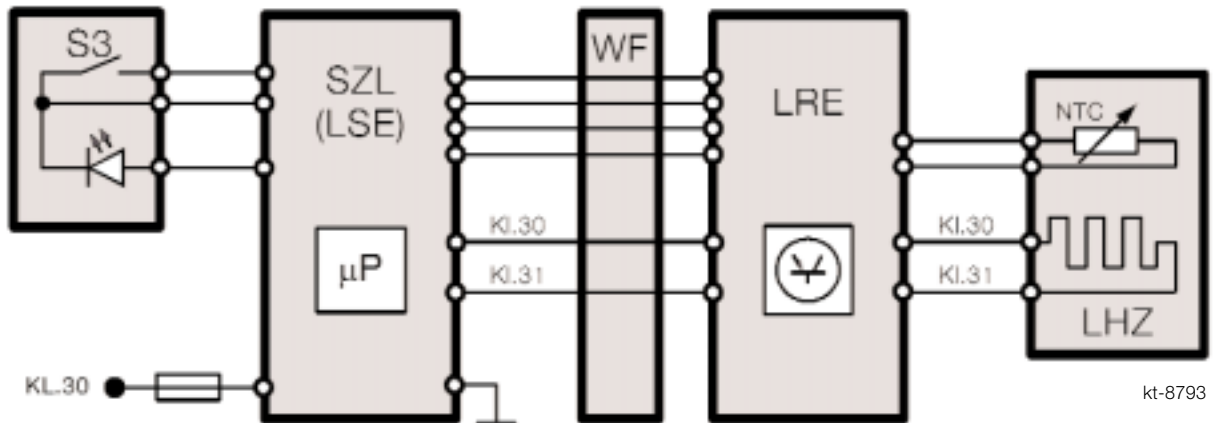

kt-8793

Index	Description	Index	Description
S3	Control button	NTC	Temperature sensor
SZL	Steering Column Switch Center	LHZ	Steering wheel heating
WF	Coil spring (contact ring)	LSE	Steering column electronics
LRE	Steering wheel electronics		

Diagnosis of Steering Wheel Heating

In the event of a fault, the steering wheel heating (LHZ) can no longer be activated (if the fault is currently present). Faults can only be diagnosed after terminal 15 "on" and an attempt to activate the steering wheel heating has been made. The following fault memory entries are available to diagnose the steering-wheel heating:

- Steering-wheel heating, heating mat, short circuit to terminal 31
- Steering-wheel heating, heating mat, short circuit to terminal 30
- Steering-wheel heating, temperature sensor faulty

The resistance value of the temperature sensor can be read out in the Diagnosis Request: "LHZ status".

Review Questions

1. Which control unit is responsible for converting the seat switch signals into bus telegrams and broadcasting them over the bus system? Where is this control unit located? _____

2. Up to how many memory positions may be stored in the seat modules? What needs to be set in VKM before all the possible memory locations can be stored? _____

3. What are the differences in the way seat heating operates and is controlled compared to the previous model (E38)? _____

4. Why are the fan motors of the ventilated seats referred to as “smart fans”? _____

5. Where are the memory positions of the exterior rear view mirrors and the steering column stored? _____
